

Varenummer: 0107057

Beskrivelse: Seeger låsering AK 40 DIN 983

Mål

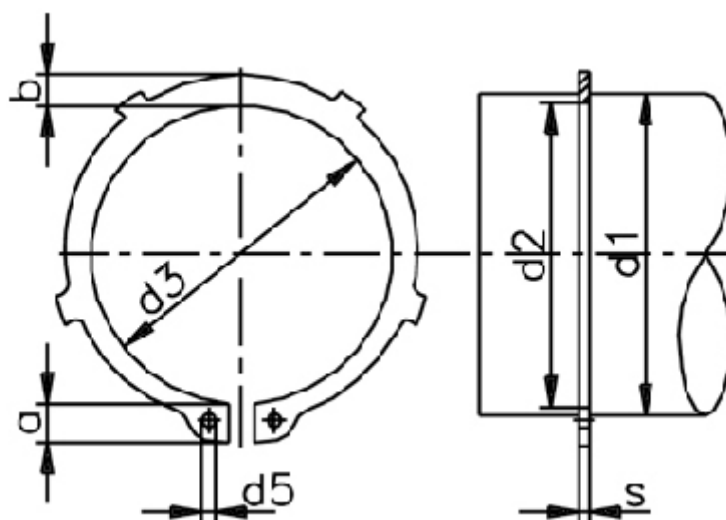

a max	= 7.2	d5 min	= 2.5	Nominal træk	= 3.8
AN mm ²	= 152.0	FN kN	= 25.30	s	= 1.75
Antal takker	= 6	FRg kN	= 9.5	t	= 1.25
b	= 4.2	FR kN	= 51.0	Tang	= ZGA-3
Betegnelse	= AK 40	g	= 2.0	tol	= -0.06
d1	= 40	K kN-mm	= 96.9	tol	= +0,39-0,90
d2	= 37.5	m min	= 1.85	tol	= -0.25
d3	= 36.5	n abl x 1000	= 14	vægt kg/1000	= 7.00